

Ventilation system Free Cooling FC-T5 and FC-T2,5 demonstrative drawings

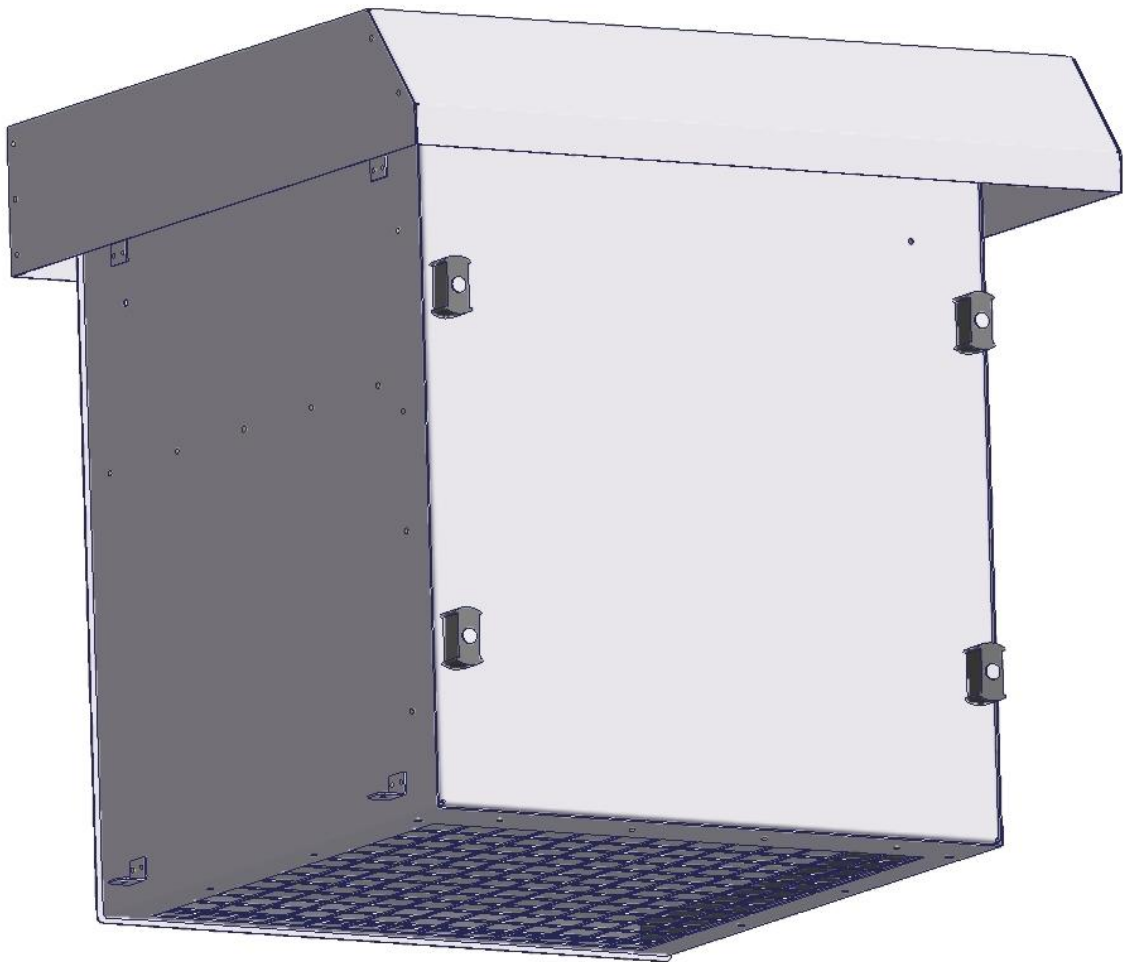

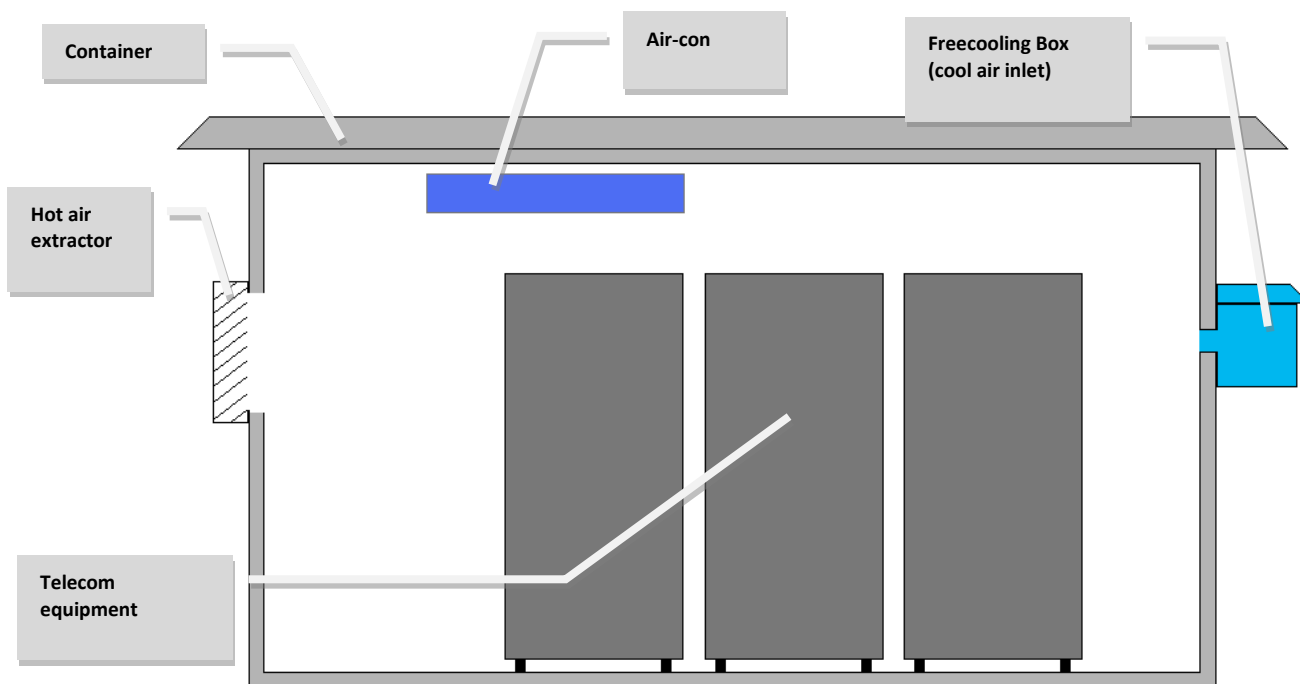

Fig 1. Overview of items layout in a container

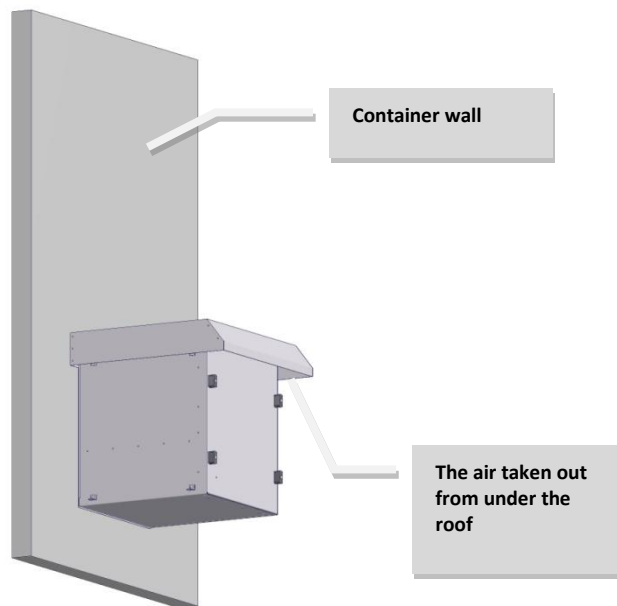

Fig 2. Cool air inlet is located at the bottom of the container

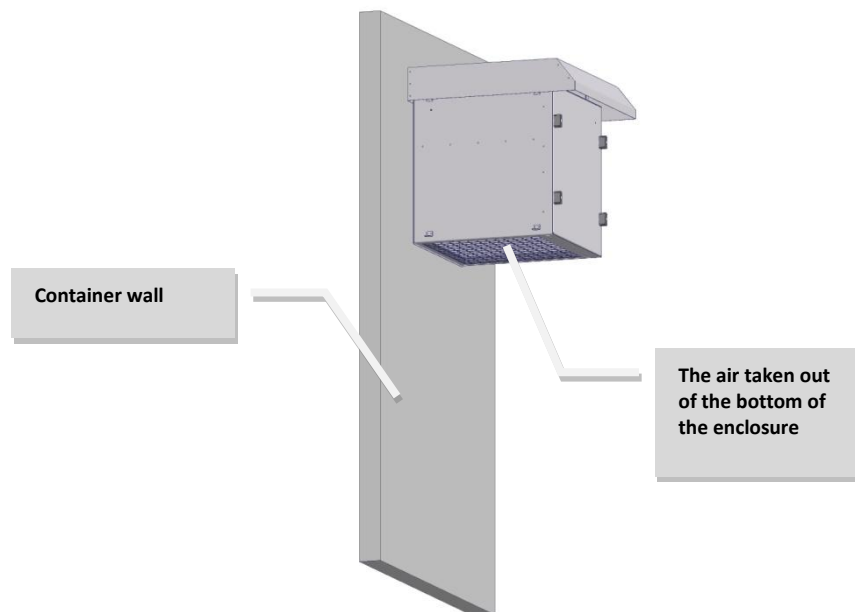

Fig 3. Cool air inlet is located at the top of the container

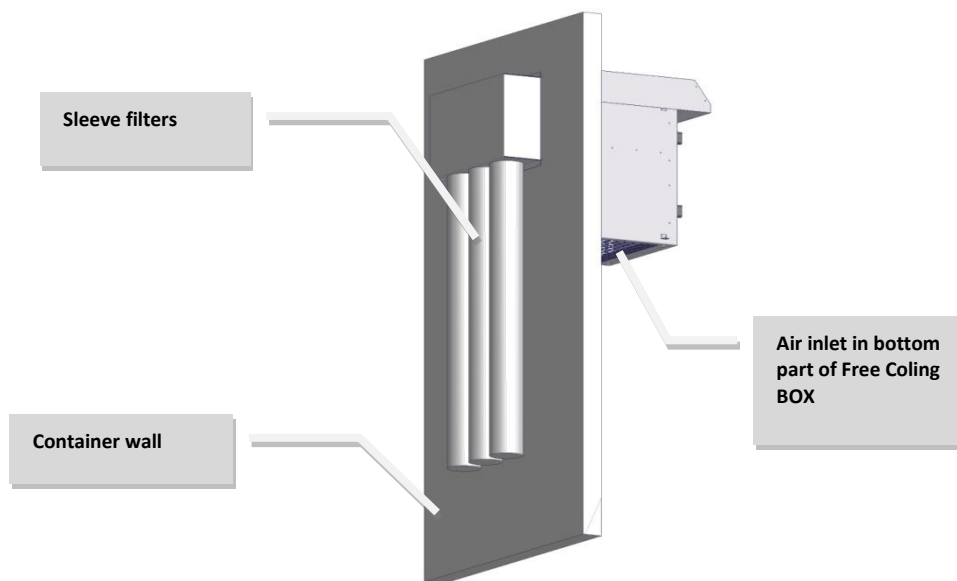

Fig 4. Air inlet in top part of container wall – possibility of using sleeve filters

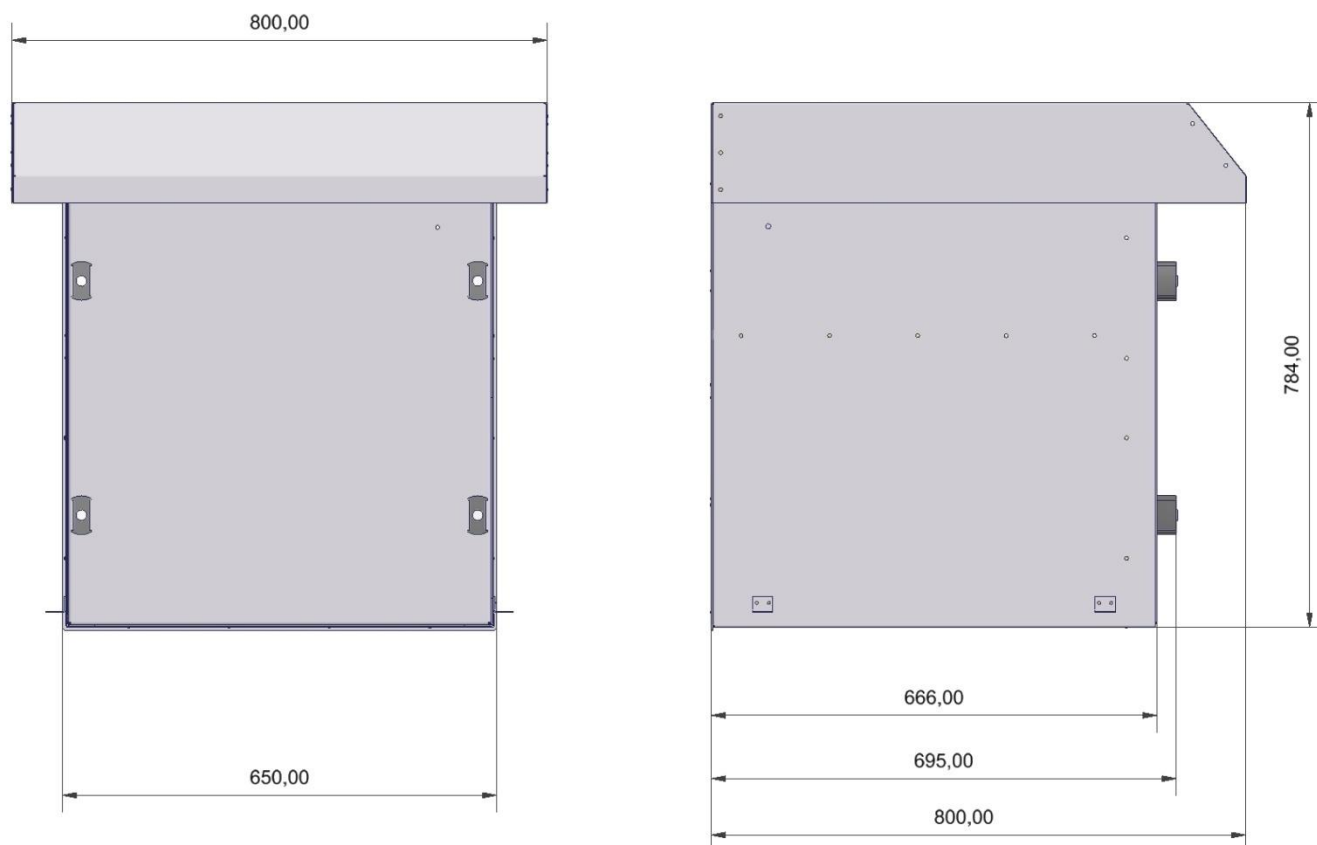

Fig 5. Freecooling Box - dimensions

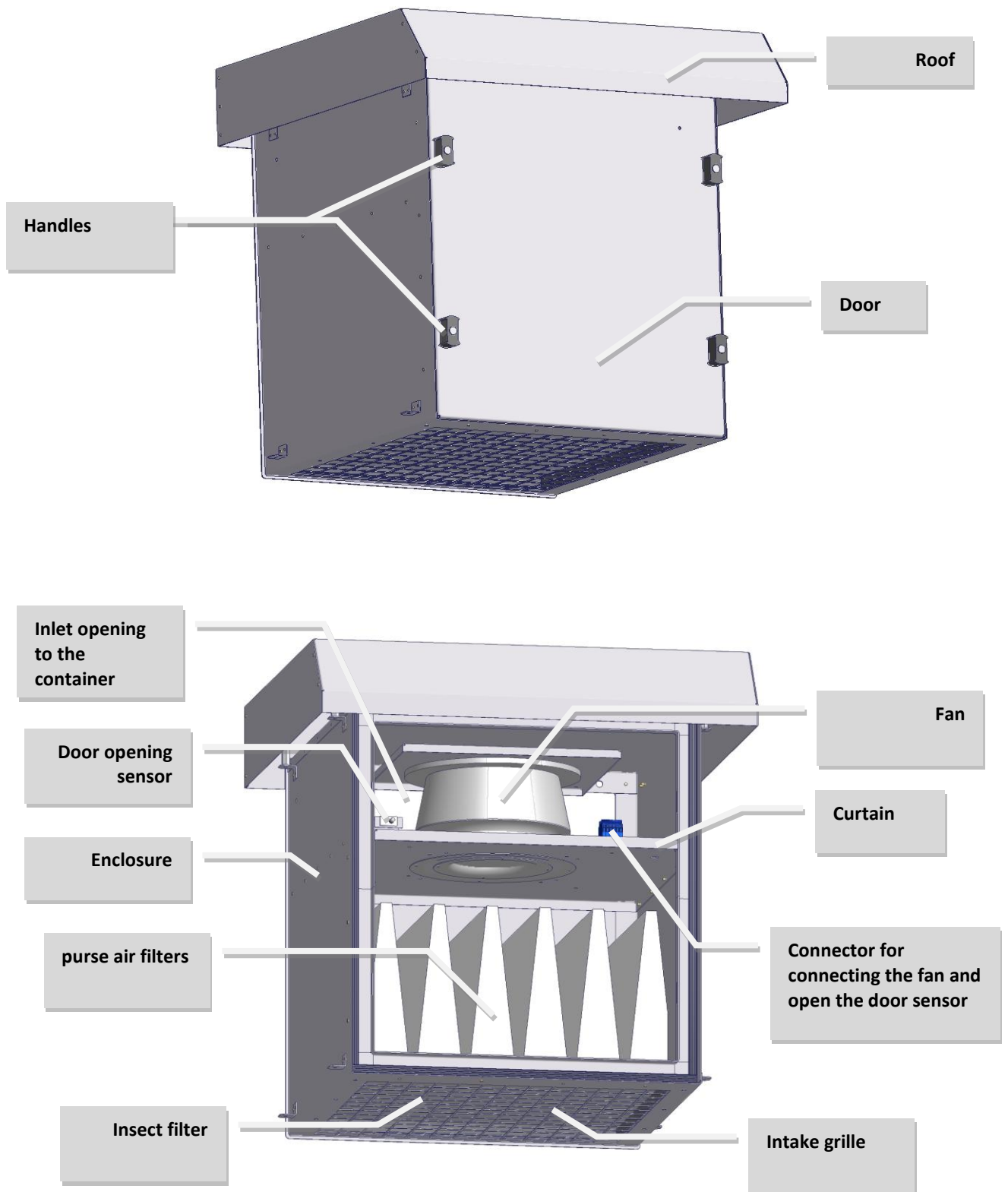

Fig 6. Freecooling BOX